

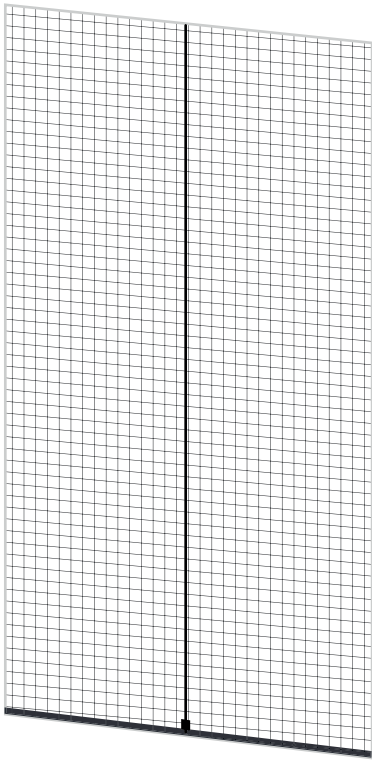

1 1x

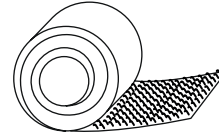

2 1x



3 1x

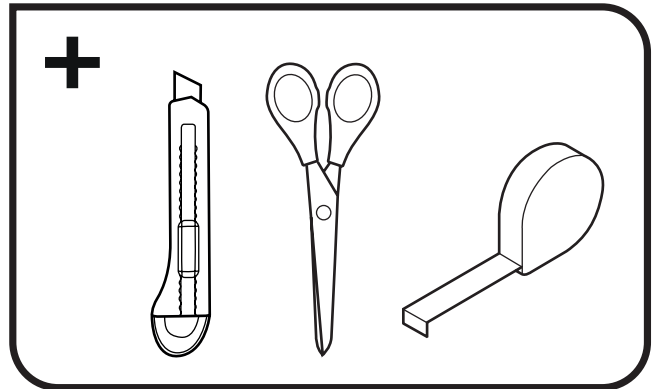
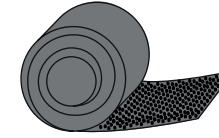

1

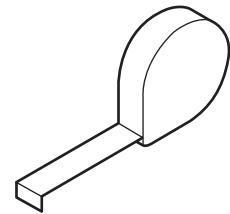
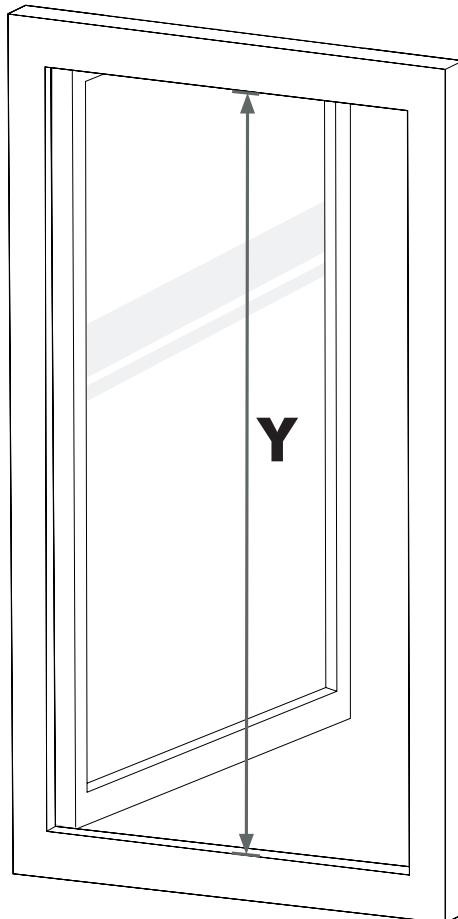

Y = \_\_\_\_\_ mm

2

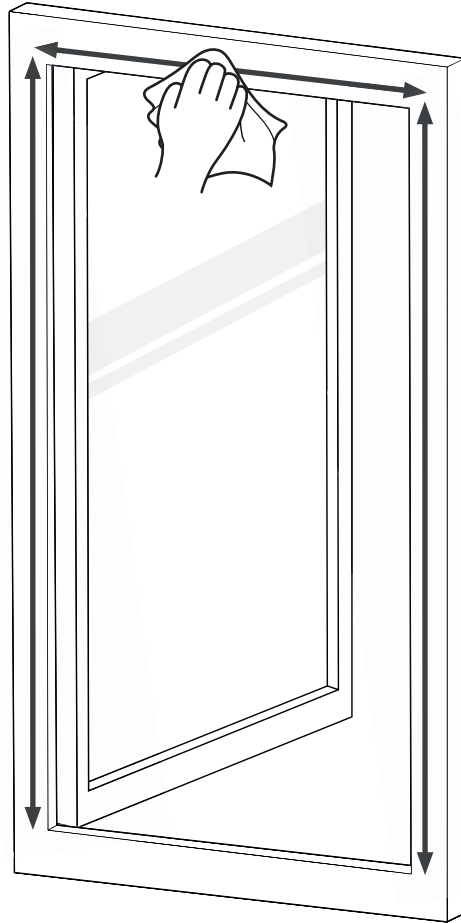

3

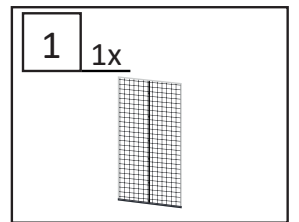
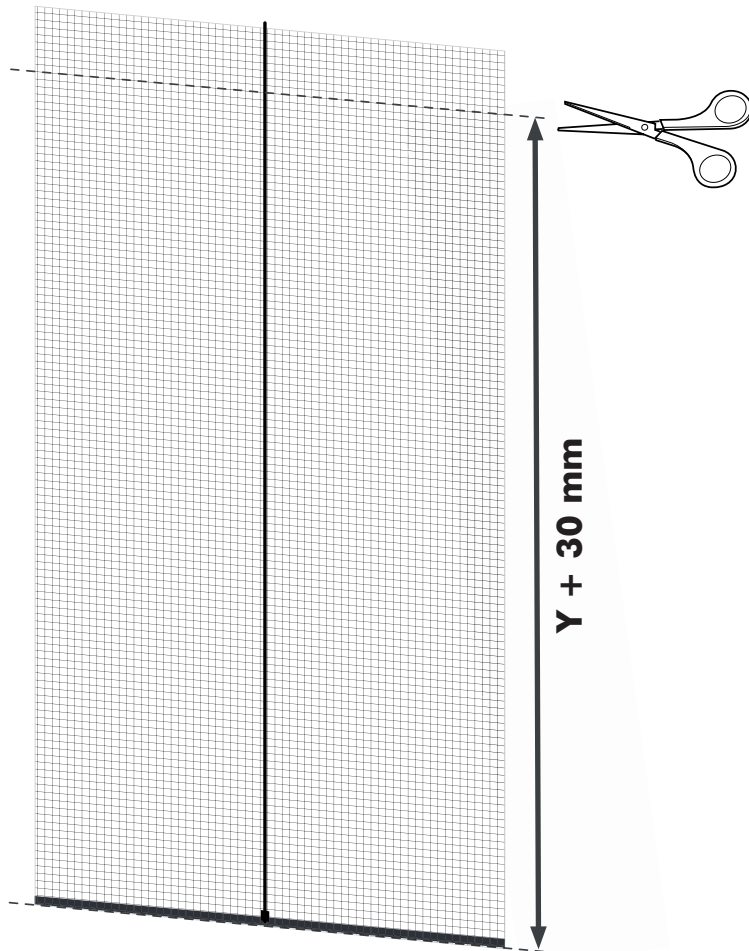

4

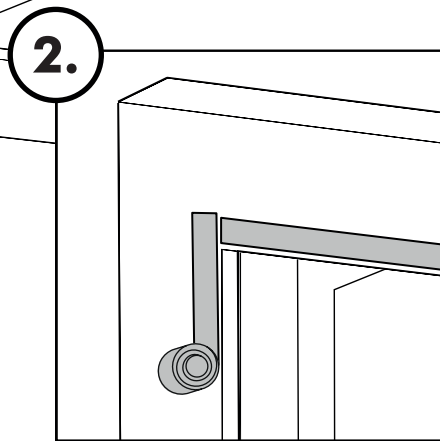
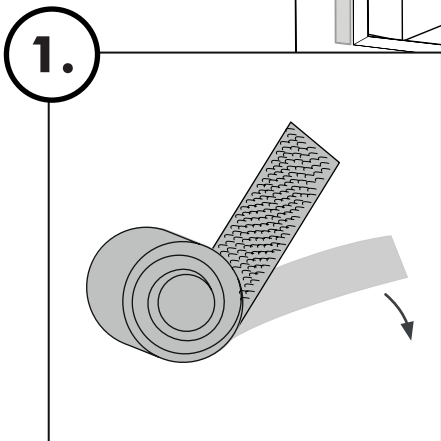
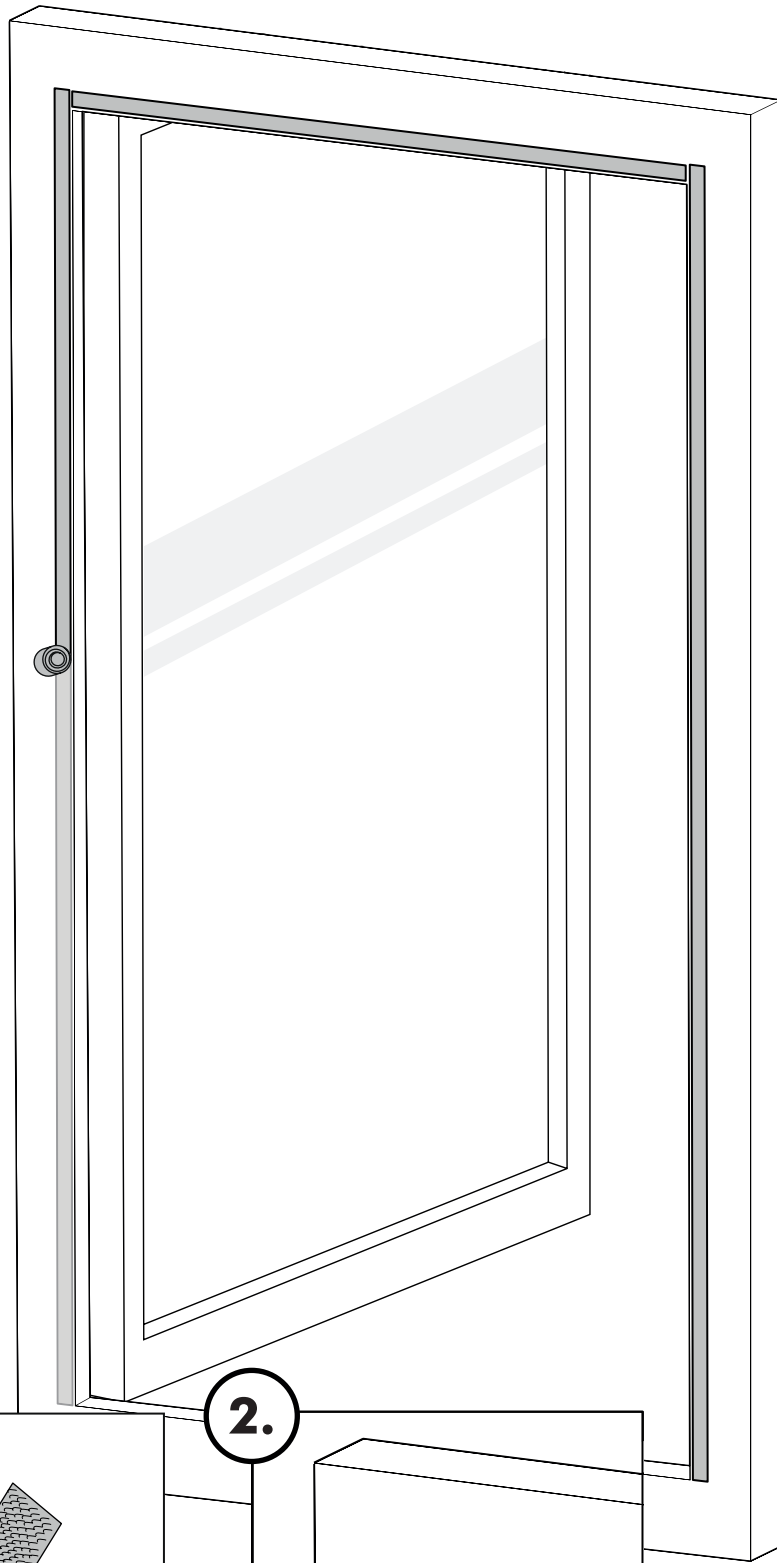
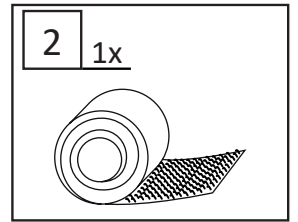

5

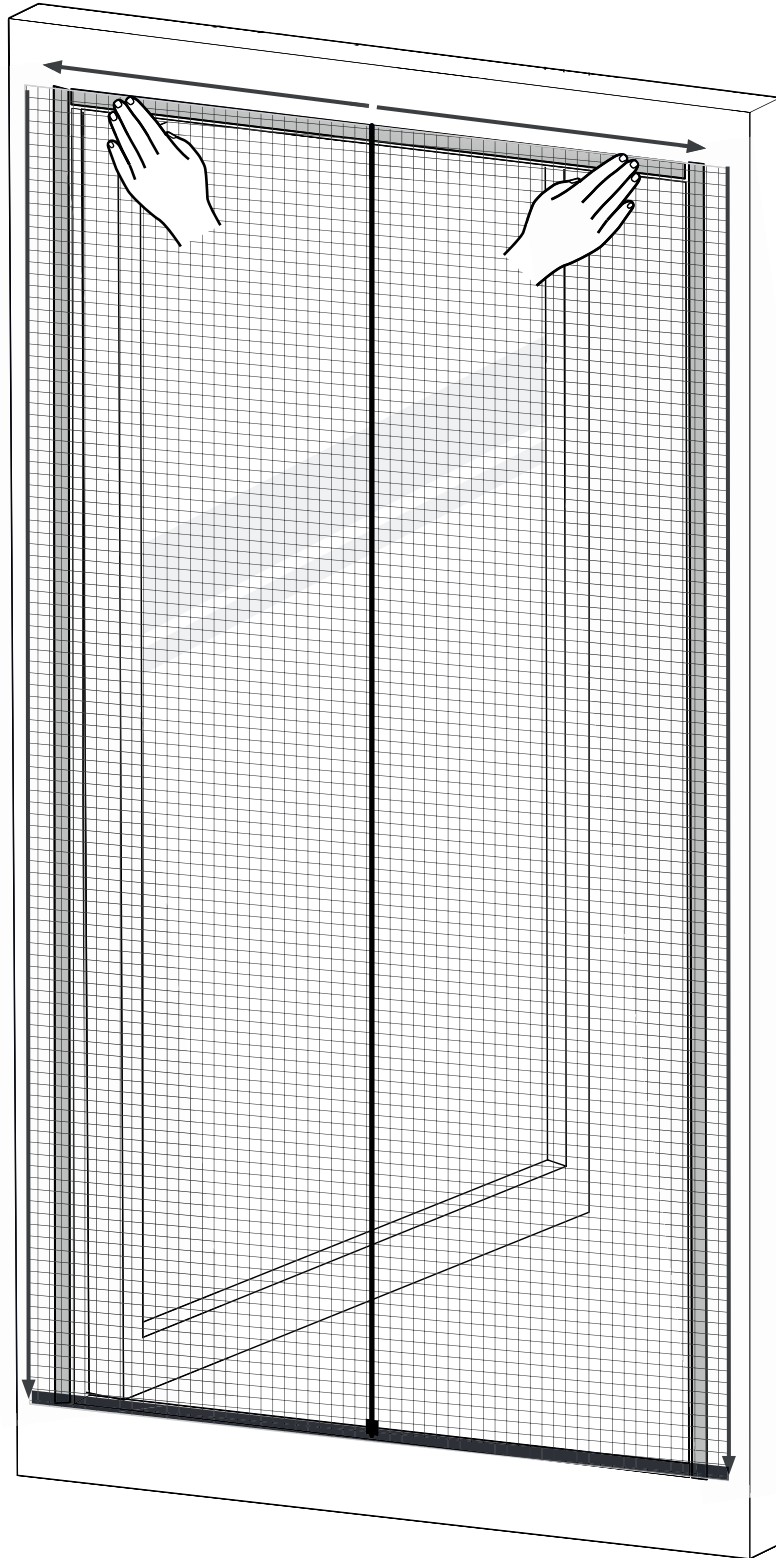
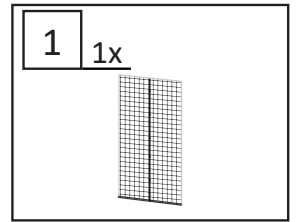

6

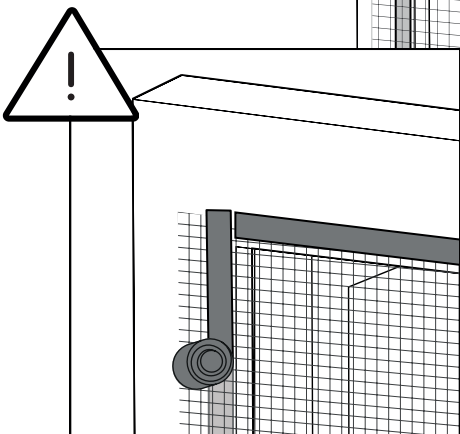
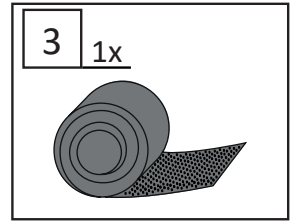

7

